



# Levo Series

## Code Blue Timers

Timing is critical during a Code Blue event for tracking and documenting appropriate patient treatment and care. With Levo Code Blue Timers and your OneVue software, you'll know the time is accurate to the exact second. Our Code Blue Timers are delivered ready to be able to immediately access your existing IT network infrastructure through PoE to document event timing and mitigate risks. Timer configuration and data storage, including time stamps for each event, are accomplished through the intuitive OneVue interface, which also provides easy access to reports and documentation of Code Blue performance.

## Accurate Timing, Better Outcomes

Specifically designed to assist medical professionals during Code Blue events, Primex Levo Code Blue Timers clearly display and record elapsed time. When the facility Code Blue alert system sends a relay/pulse to the timer, it triggers the count-up function to begin. Included switch control allows users to run, hold or reset the Timer as needed.

## Product Features:

- Multi-functional: Code Blue Timer, Clock, Count-Up or Count Down Timer
- Highly visible, 7-segment LED digits
- Three display dimmer options: 75%, 50% and 25%
- Power outage memory backup for up to 1 hour
- Choose Red or Green LED digits
- Convenient Power over Ethernet (PoE) connectivity
- Automatically adjusts for Daylight Saving Time

### ONEVUE SURFACE-MOUNT 2.5" DIGIT MODELS

6-Digits	Description
C2005X202C	4° Slope Bracket, PoE
C2005X419C	18° Slope Bracket, PoE

### ONEVUE SURFACE-MOUNT 4" DIGITS MODELS

6-Digits	Description
C2005X203C	4° Slope Bracket, PoE

### ONEVUE FLUSH-MOUNT 2.5" MODELS

6-Digits	Description
C2005X202CF	PoE

- Add a "G" after the item number for green LED models  
Example: C2007A202CG or C2007Y202CGF

## DUAL CLOCK BRACKET KIT

Any two surface-mount digital clocks can be mounted back-to-back to provide greater visibility in hallways and larger areas. Select the correct Dual Clock Bracket Kit for your application below.

### DUAL CLOCK BRACKET KIT

Mount	2", 6-Digit	4", 6-Digit*
Ceiling	26CBRK	4XBRK
Wall	26WBRK	NA

- \* 4" 6-digit Clock can be ceiling mount only.



Surface-Mount Timer



Flush-Mount Timer  
Includes clock, junction box and face plate.



Wall Mount Timer



Ceiling Mount Timer

## CODE BLUE TIMER SPECIFICATIONS:

- 12- or 24-hour time display
- PM indicator light
- Automatically adjust for Daylight Saving Time
- Clock configuration to access your network is accomplished online prior to delivery for plug-and-play convenience.
- Alternating time and date display option
- LED dimmer option (75%, 50%, 25%)
- Power outage memory backup for up to 1 hour
- Operating temperature range: 32°- 95°F (0°- 35°C)
- Storage temperature range: -20°-185°F (-29°- 85°C)

### Audible Tone Option

- Only on the count-up and count-down timer function
- Frequency: 3KHZ +/-0.5KHZ

### PoE

- PoE IEEE 802.3af compliant
- Certification: FCC/IC/CE marked
- Peak power consumption: 12.9 watts (class 3)

## CODE BLUE TIMER SWITCH CONTROL SPECIFICATIONS:

- Allows the user to run, hold or reset the Code Blue Timer
- Designed to fit inside a single gang box (not included)
- Membrane switch and wall plate clean easily and resist common cleaners and disinfectants

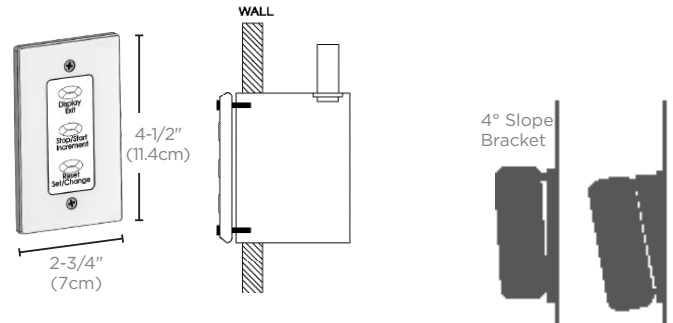

### CODE BLUE TIMER DIMENSIONS

Timer Type	Weight	Height	Width	Depth
		A	B	C
2.5" (6.4cm), 6-digit	2.0 lbs. (0.9 kg)	5.0" (12.7cm)	13.8" (34.9cm)	2.2" (5.6cm)
4" (10.16cm), 6-digit	4.6 lbs. (2.1 kg)	8.0" (20.3cm)	23.3" (59.2cm)	2.4" (6.1cm)

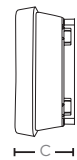
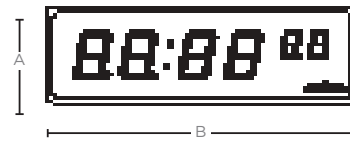

### DUAL-MOUNT DIMENSIONS

Timer Type	Width from Wall	Height from Ceiling	Depth of Two Clocks
	A	B	C
Dual 2.5" (6.4cm), 6-digit	16.8" (42.7cm)	8.0" (20.3cm)	5.9" (15.0cm)
Dual 4" (10.16cm), 6-digit	NA*	11.0" (27.9cm)	6.3" (16.0cm)

\* 4", 6-digit clocks cannot be dual-mounted to the wall.

Note: Dual mount clocks are shipped disassembled to simplify installation.

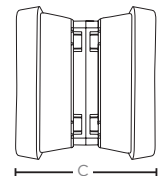
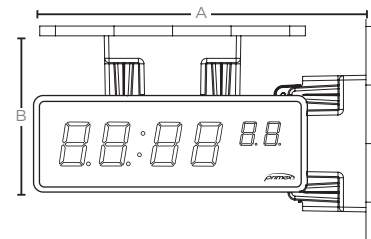

### CODE BLUE FLUSH-MOUNT TIMER DIMENSIONS

Timer Type	Weight	Width	Height	Depth
		A	B	C
2.5" (6.4cm), 6-digit	2.0 lbs. (0.9 kg)	16.8" (42.7cm)	6.5" (16.5cm)	3.4" (8.6cm)

When ordering for new construction projects, the junction boxes for flush-mount installation may be ordered to ship in advance of clocks. Please request special shipping and provide dates when ordering.

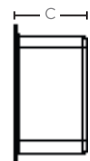
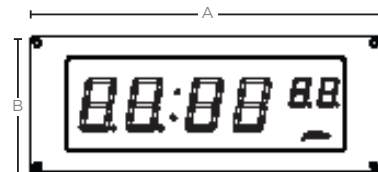

To Learn More:  
Call 800.537.0464  
Email: info@primexinc.com

primexinc.com



OneVue is a trademark of Primex. The innovative technology software solution for facility and time synchronization monitoring and reporting. All other trademarks are the property of their respective owners.

©2017 Primex. The Primex logo is a registered trademark of Primex. All Rights Reserved. 4.17